

# MedioVis Framework

## Integration of a Hierarchical Data Structure

*Werner A. König*

*Practical Master Course*

*WG Human-Computer Interaction  
University of Konstanz*



- History
- Requirements, Complexity & Functionality
- MedioVis Framework
- Start Sequence
- Observer & Singleton Pattern
- Data Handling
- Data Model – Table vs. Tree
- Results & Basket
- Selection, Filtering & Focus
- Future Work

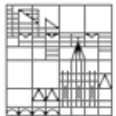

- Insyder
- 2002: INVISIP (XML, DB)
- May 2003: INVISIP, Redesign Data Model
- January 2004: MedioVis, Redesign Framework
- September 2004: MedioVisX, Refactoring Framework
- January 2005: MedioVisX, Multi-Dimensional Data (IMDb)
- October 2005: MedioVisX<sup>T</sup>, Hierarchical Data Integration



...



## Flexibility in the area of...

- Data Input
- Information Retrieval
- Data Handling
- Visualizations
- Window Segmentation
- Interaction (internal & global)
- General Appearance

## Flexibility in terms of...

- Integration
- Modification
- Extension

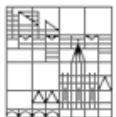

- Data Organization:
  - Heterogeneous Data (string, integer, image, movie,...)
  - Multi-Dimensional Data (meta data, relationships, dependancies)
  - Hierarchical Data (arbitrarily tree structure)
- Basket & Result (independent data, identical interface)
- Temporary and persistent data handling
  - No unique data identifier (hash comparison)
- Different Data Resources and Types
- Performance (dynamic interaction, large information space)

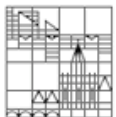

- Multilevel Abstraction, well defined interfaces
- Intelligent loading and rendering techniques
- Client / Server architecture
- Variable Assignments
- Dynamic Filtering
  - Local & global
- Sorting
- History

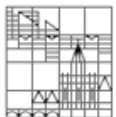

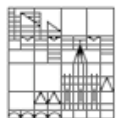
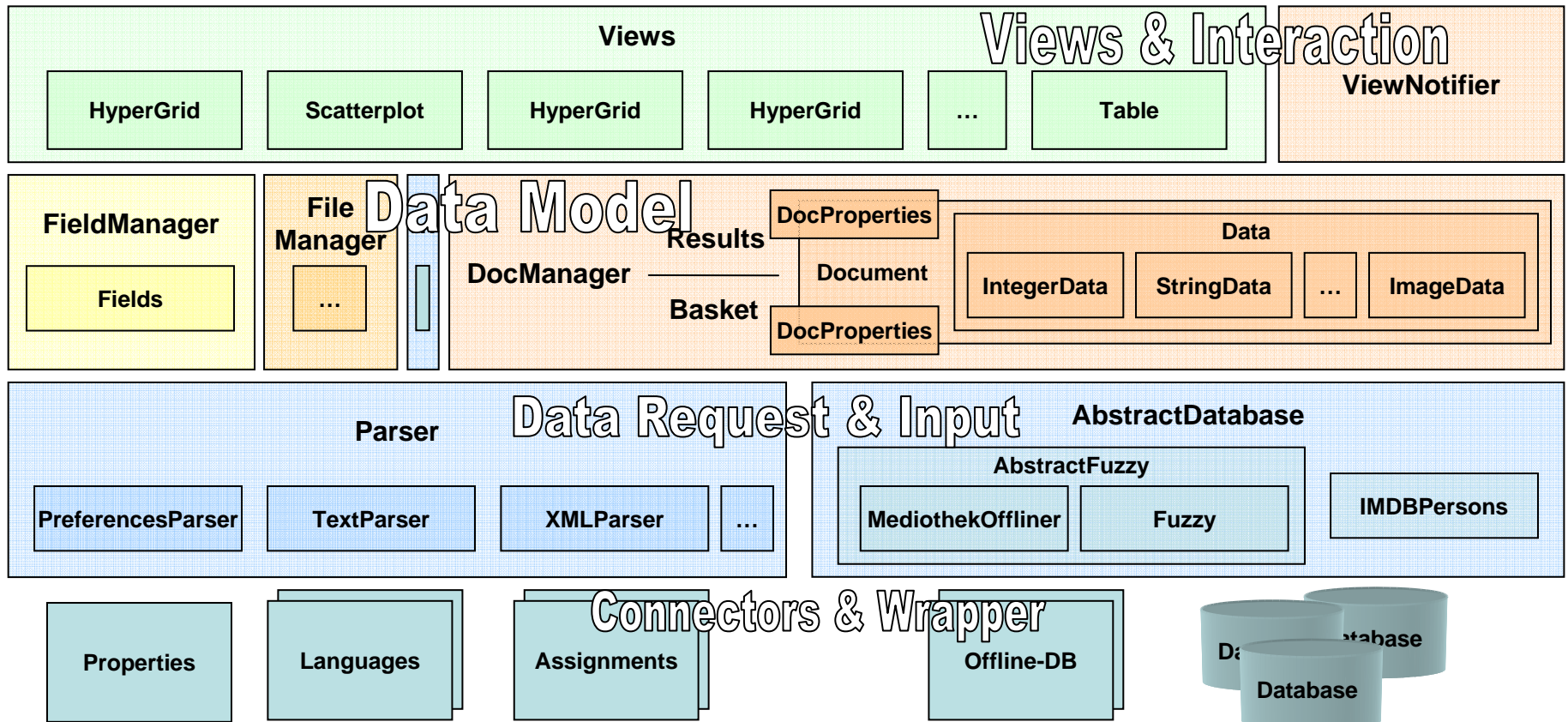

# Start Sequence

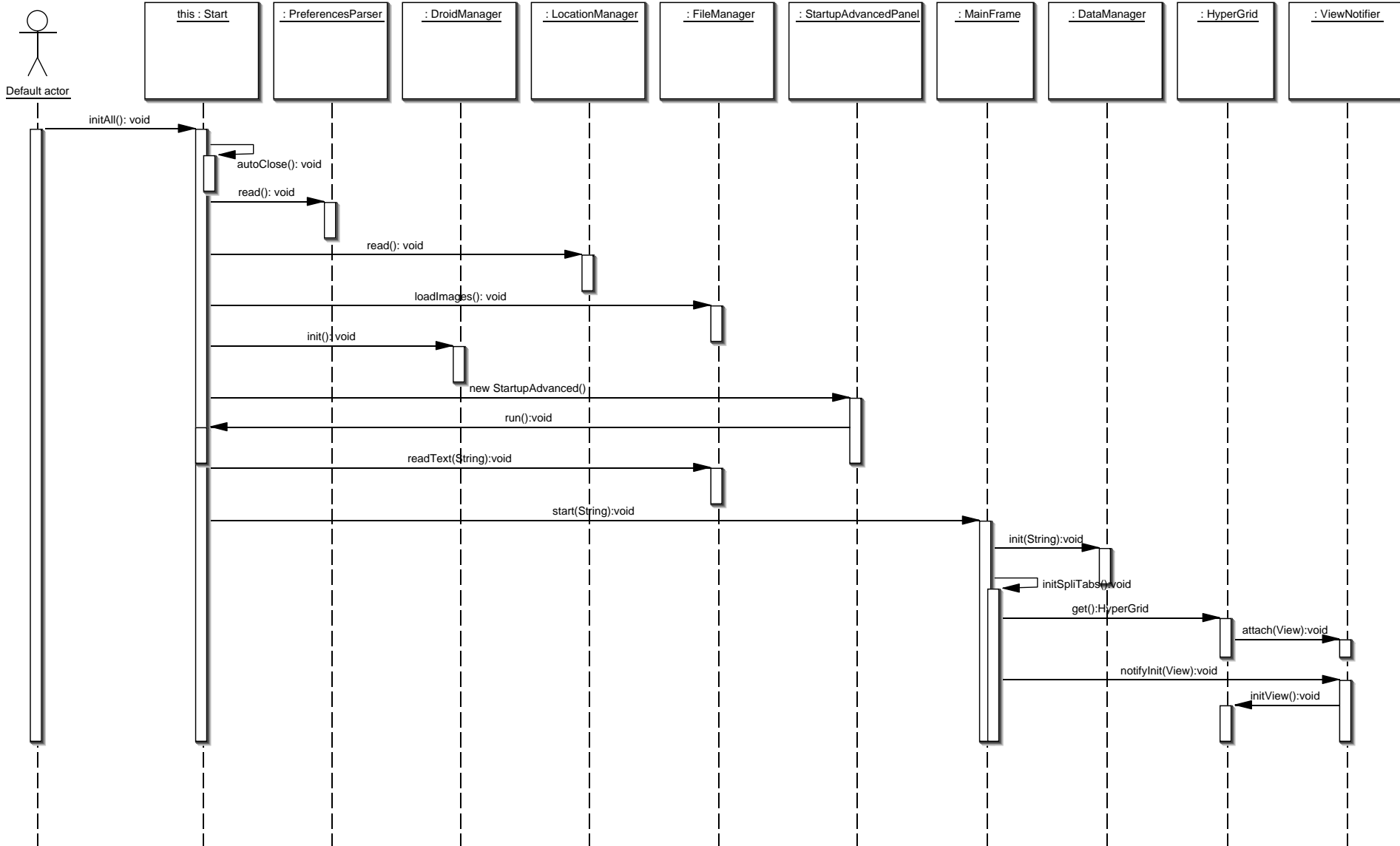



# Observer & Singleton Pattern

9

```
public interface View {
    public abstract void initView();
    public abstract void updateView();
    public abstract void repaintView();
    public abstract void repaintSelection(int id);
    public abstract void repaintFocus(Document doc);
    public abstract void repaintZoom(int[] ids, int diff);
    public abstract void finish();
}
```

```
public class ViewNotifier {
    private static View[] views;
    public static void attach(View view) {}
    public static void notifyInit() {}
    public static void notifyUpdate() {}
    public static void notifyRepaint() {}
    public static void notifySelection(View source, int id) {}
    public static void notifyFocus(View source, int id,
        String hash) {}
    public static void notifyZoom(View source, int[] ids,
        int diff){}
    public static void notifyFinish() {}
    ...
}
```

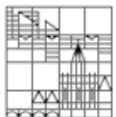

Werner A. Koenig  
WG Human-Computer Interaction,  
University of Konstanz, Germany.

```
public class HyperGrid extends JPanel
    implements View {
    private static HyperGrid instance;
    private HyperGrid() {
        ViewNotifier.attach(this);
        ...
    }

    public static HyperGrid get() {
        if(instance == null) instance = new HyperGrid();
        return instance;
    }

    public void initView() {}
    public void updateView() {}
    public void repaintView() {}
    public void repaintSelection(int id) {}
    public void repaintFocus(Document doc) {}
    public void repaintZoom(int[] id, int diff) {}
    public void finish() {}
    ...
}
```

Practical Master Course  
Project MedioVis  
10/24/2005

MedioVis 0.70m (Jean-Luc) - ein neues Suchsystem für die Mediothek der UB Konstanz!

spielberg   **spielberg** 22 Treffer  **MedioVis**

Titel	Personen	Jahr	Sprache	Medientyp	Signatur	Ausleihstatus
<a href="#">Der Soldat James Ryan</a>	Spielberg, Steven; Hanks, Tom; Bur...	1999	dt.	Video	6 tff 710:s755/s19	<a href="#">verfügbar (Frist: 1 Woche)</a>
<a href="#">Die Farbe Lila</a>	Spielberg, Steven; Glover, Danny; C...	1985	dt.	Video	6 tff 710:s755/c65a	<a href="#">verfügbar (Frist: 1 Woche)</a>
<a href="#">Duell</a>	Spielberg, Steven; Weaver, Dennis...	1971	dt.	Video	6 tff 710:s755/d92	<a href="#">unbekannt</a>
<a href="#">E. T.</a>	Spielberg, Steven; Wallace, Dee; Co...	1988	engl.	Video	6 tff 710:s755/e90	<a href="#">verfügbar (Frist: 1 Woche)</a>
<a href="#">Hook</a>	Spielberg, Steven; Hoffman, Dustin...	1991	dt.	Video	6 eng 959:b275:k/h66	<a href="#">verfügbar (Frist: 1 Woche)</a>
<a href="#">Indiana Jones and the last crusade</a>	Spielberg, Steven; Ford, Harrison; ...	1988	dt.	Video	6 tff 710:s755/i62a	<a href="#">ausleihen bis: 27.10.2005</a>
<a href="#">Indiana Jones and the temple of doom</a>	Spielberg, Steven; Ford, Harrison; ...	1984	dt.	Video	6 tff 710:s755/i62	<a href="#">verfügbar (Frist: 1 Woche)</a>
<a href="#">Jurassic Park</a>	Spielberg, Steven; Crichton, Micha...	1993	dt.	Video	6 tff 710:s755/j97	<a href="#">verfügbar (Frist: 1 Woche)</a>
<a href="#">Minority Report</a>	Spielberg, Steven; Frank, Scott; Di...	2003	engl.+dt.	DVD	6 ame 959:d547:k/m46	<a href="#">ausleihen bis: 26.10.2005</a>
<a href="#">Raiders of the lost ark</a>	Spielberg, Steven; Ford, Harrison; ...	1981	dt.	Video	6 tff 710:s755/r14	<a href="#">verfügbar (Frist: 1 Woche)</a>
<a href="#">Schindler's list</a>	Spielberg, Steven; Zaillian, Steven; ...	1993	engl.	Video	6 tff 710:s755/s22a	<a href="#">verfügbar (Frist: 1 Woche)</a>
<a href="#">Schindlers Liste</a>	Spielberg, Steven; Zaillian, Steven; ...	1995	dt.	Video	6 tff 710:s755/s22	<a href="#">verfügbar (Frist: 1 Woche)</a>
<a href="#">Steven Spielberg über Schindlers Liste</a>	Blair, Jon; Spielberg, Steven	1996	dt.	Video	6 tff 710:s755/h67 [ang...	<a href="#">unbekannt</a>
<a href="#">Survivors of the Holocaust</a>	Holzman, Allan; Spielberg, Steven	1995	engl.	Video	6 gsx 528.22/h65	<a href="#">verfügbar (Frist: 1 Woche)</a>
<a href="#">The American Film Institute salute to Ste...</a>	Horvitz, Louis J.; Shrum, Robert; S...	1995	dt.	Video	6 tff 710:s755/h67	<a href="#">verfügbar (Frist: 1 Woche)</a>

Details

**Die Farbe Lila**

**Beschreibung:** [Darst.:] Danny Glover, Adolph Caesar, Margaret Avery ...  
 Music: Quincy Jones. Director of photography: Allen Daviau. Based upon the novel by Alice Walker. Screenplay by Menno Meyjes. Director of photography: Allen Daviau. Directed by Steven Spielberg

**Medientyp:** Video  
**Details:** Spielfilm, Literaturverfilmung, USA 1985  
**Jahr:** 1985  
**Original:** The color purple [dt.]  
**Sprache:** dt.  
**Format:** 1 Videokassette [VHS] (160 Min.): farb.  
**Herausgeber:** Warner Bros. Inc.  
**Stadt:** [s.l.]  
**Fachgebiet:** Theater/Tanz/Film/Funk/Fernsehen  
**Signatur:** 6 tff 710:s755/c65a  
**Ausleihstatus:** verfügbar (Frist: 1 Woche)  
**Beliebtheit:** 23x ausgeliehen

Standort | Merkliste



MedioVis 0.70m (Jean-Luc) - ein neues Suchsystem für die Mediothek der UB Konstanz!

spielberg 22 Treffer

Titel	Personen	Jahr	Sprache	Medientyp	Signatur	Ausleihstatus
<Zum Verfeinern Begriffe eingeben>	<Zum Verfeinern Begriffe eingeben>	<Zum Verfeinern Begriffe eingeben>	<Zum Verfeinern Begriffe eingeben>	<Zum Verfeinern Begriffe eingeben>	<Zum Verfeinern Begriffe eingeben>	<Zum Verfeinern Begriffe eingeben>
Der Soldat James Ryan	Spielberg, Steven; Hanks, Tom; Bur...	1999	dt.	Video	6 tff 710:s755/s19	verfügbar (Frist: 1 Woche)
Die Farbe Lila	Spielberg, Steven; Glover, Danny; C...	1985	dt.	Video	6 tff 710:s755/c65a	verfügbar (Frist: 1 Woche)
Duell	Spielberg, Steven; Weaver, Dennis...	1971	dt.	Video	6 tff 710:s755/d92	unbekannt
E. T.	Spielberg, Steven; Wallace, Dee; Co...	1988	engl.	Video	6 tff 710:s755/e90	verfügbar (Frist: 1 Woche)
Hook	Spielberg, Steven; Hoffman, Dustin...	1991	dt.	Video	6 eng 959:b275:k/h66	verfügbar (Frist: 1 Woche)
Indiana Jones and the last crusade	Spielberg, Steven; Ford, Harrison; ...	1988	dt.	Video	6 tff 710:s755/i62a	ausgeliehen bis: 27.10.2005
Indiana Jones and the temple of doom	Spielberg, Steven; Ford, Harrison; ...	1984	dt.	Video	6 tff 710:s755/i62	verfügbar (Frist: 1 Woche)
Jurassic Park	Spielberg, Steven; Crichton, Micha...	1993	dt.	Video	6 tff 710:s755/j97	verfügbar (Frist: 1 Woche)
Minority Report	Spielberg, Steven; Frank, Scott; Di...	2003	engl.+dt.	DVD	6 ame 959:d547:k/m46	ausgeliehen bis: 26.10.2005
Raiders of the lost ark	Spielberg, Steven; Ford, Harrison; ...	1981	dt.	Video	6 tff 710:s755/r14	verfügbar (Frist: 1 Woche)
Schindler's list	Spielberg, Steven; Zaillian, Steven; ...	1993	engl.	Video	6 tff 710:s755/s22a	verfügbar (Frist: 1 Woche)
Schindlers Liste	Spielberg, Steven; Zaillian, Steven; ...	1995	dt.	Video	6 tff 710:s755/s22	verfügbar (Frist: 1 Woche)
Steven Spielberg über Schindlers Liste	Blair, Jon; Spielberg, Steven	1996	dt.	Video	6 tff 710:s755/h67 [ang...	unbekannt
Survivors of the Holocaust	Holzman, Allan; Spielberg, Steven	1995	engl.	Video	6 gsx 528.22/h65	verfügbar (Frist: 1 Woche)
The American Film Institute salute to Ste...	Horvitz, Louis J.; Shrum, Robert; S...	1995	dt.	Video	6 tff 710:s755/h67	verfügbar (Frist: 1 Woche)

Details | Die Farbe Lila

**Beschreibung:** [Darst.] Danny Glover, Adolph Caesar, Margaret Avery ...  
 Music: Quincy Jones. Director of photography: Allen Daviau. Based upon the novel by Alice Walker. Screenplay by Menno Meyjes. Director of photography: Allen Daviau. Directed by Steven Spielberg

**Medientyp:** Video  
**Details:** Spielfilm, Literaturverfilmung, USA 1985  
**Jahr:** 1985  
**Original:** The color purple [dt.]  
**Sprache:** dt.  
**Format:** 1 Videokassette [VHS] (160 Min.): farb.  
**Herausgeber:** Warner Bros. Inc.  
**Stadt:** [s.l.]  
**Fachgebiet:** Theater/Tanz/Film/Funk/Fernsehen  
**Signatur:** 6 tff 710:s755/c65a  
**Ausleihstatus:** verfügbar (Frist: 1 Woche)  
**Beliebtheit:** 23x ausgeliehen

Standort | Merkliste |

FieldManager

Document

DocManager

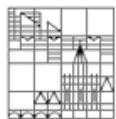

# D.M. Table

```
public class DocManager implements DataTypes, Serializable {
    private Document[] DOCS = new Document[capacity];
    private int[] sortedIDs = new int[capacity];
    private int[] sortedRows = new int[capacity];
    ...
    public Document getDoc(int id) {
        return DOCS[id];
    }
    public int getID(Document doc) {
        return HASH.getID(doc);
    }
    public int getID(int row) {
        return sortedIDs[row];
    }
    public int getRow(int id) {
        return sortedRows[id];
    }
    public void sortDocs() {
        sortDocs(lastSorted, lastOrdered);
        FileManager.preloading(this);
    }
}
```

```
public class Document implements Serializable {
    private Data[] data;
    private boolean selected, focused;
    private boolean availableHGrid, availablePlot;
    ...
    public Data getData(int field) {
        return data[field];
    }
}
```

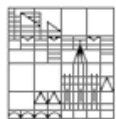
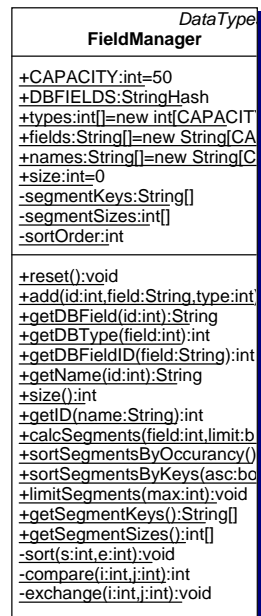
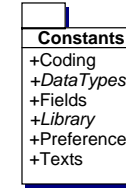
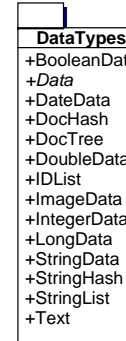
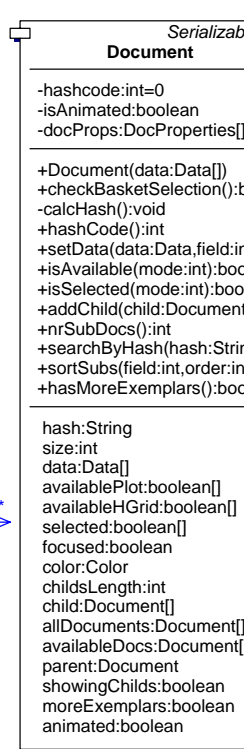
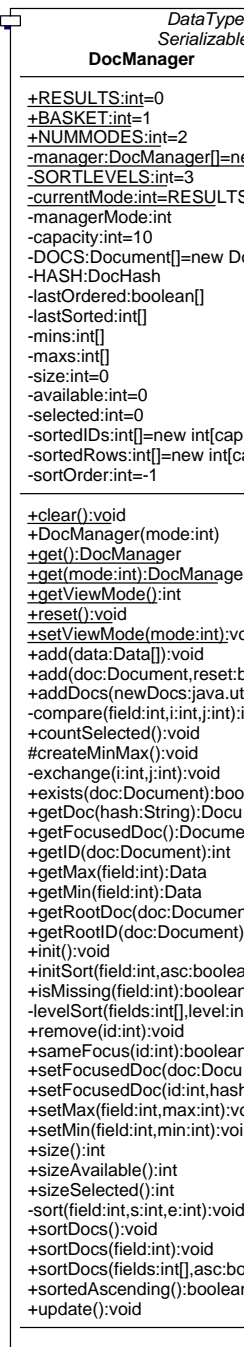

# Mediothek - Tree Structure

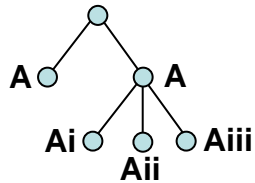
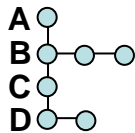

Several Copies

Multipart Items

Der Brockhaus Philosophie	Conradi, Elisabeth	2004	dt.	Buch	inf 425:s/b76...	<a href="#">mehrere Exemplare</a>
Der Brockhaus Psychologie	Starke-Perschke, Susanne; Bliesene...	2001	dt.	Buch	inf 435:s/s91	<a href="#">nicht ausleihbar</a>
Der Brockhaus Zeitgeschichte	Hotz, Jürgen; Schaaf, Michael	2003	dt.	Buch	gsx 10:c/h69	<a href="#">verfügbar</a>
Der Brockhaus-Atlas zur Geschichte	Hotz, Jürgen; Engehausen, Frank	2005	dt.	Buch	gsb 860/h69	<a href="#">verfügbar</a>
<b>Der grosse Brockhaus</b>			dt.	diverse	N 78/207... N 78/207 inf 171:c/ff16	<a href="#">mehrere Exemplare</a> <a href="#">mehrtteiliges Werk</a> <a href="#">unbekannt</a>
A - Beo		1952	dt.	Buch	N 78/207-1 N 78/207-1	<a href="#">mehrere Exemplare</a> <a href="#">verfügbar</a> <a href="#">nicht ausleihbar</a>
Atlas : Erdkunde, Wirtschaft, Geschichte		1960	dt.	Buch	N 78/207-Atlas... N 78/207-Atlas... inf 171:c/ff16-15	<a href="#">mehrere Exemplare</a> <a href="#">verfügbar</a> <a href="#">nicht ausleihbar</a>
Ber - Cz		1953	dt.	Buch	N 78/207-2... N 78/207-2 inf 171:c/ff16-2	<a href="#">mehrere Exemplare</a> <a href="#">verfügbar</a> <a href="#">nicht ausleihbar</a>
D - Faz		1953	dt.	Buch	N 78/207-3... N 78/207-3 inf 171:c/ff16-3	<a href="#">mehrere Exemplare</a> <a href="#">verfügbar</a> <a href="#">nicht ausleihbar</a>
Ergänzungsband		1958	dt.	Buch	N 78/207-13... N 78/207-13 inf 171:c/ff16-13	<a href="#">mehrere Exemplare</a> <a href="#">verfügbar</a> <a href="#">nicht ausleihbar</a>
Ergänzungsband : 2, A - Z		1963	dt.	Buch	N 78/207-14... N 78/207-14 inf 171:c/ff16-14	<a href="#">mehrere Exemplare</a> <a href="#">verfügbar</a> <a href="#">nicht ausleihbar</a>
Fba - Goz		1954	dt.	Buch	N 78/207-4... N 78/207-4 inf 171:c/ff16-4	<a href="#">mehrere Exemplare</a> <a href="#">verfügbar</a> <a href="#">nicht ausleihbar</a>
Gp - Iz		1954	dt.	Buch	N 78/207-5... N 78/207-5 inf 171:c/ff16-5	<a href="#">mehrere Exemplare</a> <a href="#">verfügbar</a> <a href="#">nicht ausleihbar</a>
J - Kz		1955	dt.	Buch	N 78/207-6... N 78/207-6 inf 171:c/ff16-6	<a href="#">mehrere Exemplare</a> <a href="#">verfügbar</a> <a href="#">nicht ausleihbar</a>
L - Mij		1955	dt.	Buch	N 78/207-7... N 78/207-7	<a href="#">mehrere Exemplare</a> <a href="#">verfügbar</a>

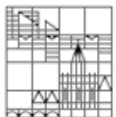

# D.M. Tree

```
public class DocManager implements DataTypes, Serializable {
    private Document[] DOCS = new Document[capacity];
    private int[] sortedIDs = new int[capacity];
    private int[] sortedRows = new int[capacity];
    ...
    public Document getRootDoc(Document doc) {
    }
}
```

```
public class Document implements Serializable {
    private Data[] data;
    private Document[] childs = null;
    private Document parent = null;
    private boolean showingChilds = false;
    private DocProperties[] docProps;
    ...
    public Document[] getAllDocuments() {...}
    public Document[] getAvailableDocs(int mode) {...}
    public Document searchByHash(String hash){...}
}
```

```
public class DocProperties implements Serializable {
    private boolean availablePlot = true;
    private boolean availableHGrid = true;
    private boolean selected = false;
    private Document doc = null;
    ...
}
```

- Strong use of recursion
- Pretend flat array for non-hierarchical

## Viz



Werner A. Koenig  
 WG Human-Computer Interaction,  
 University of Konstanz, Germany.

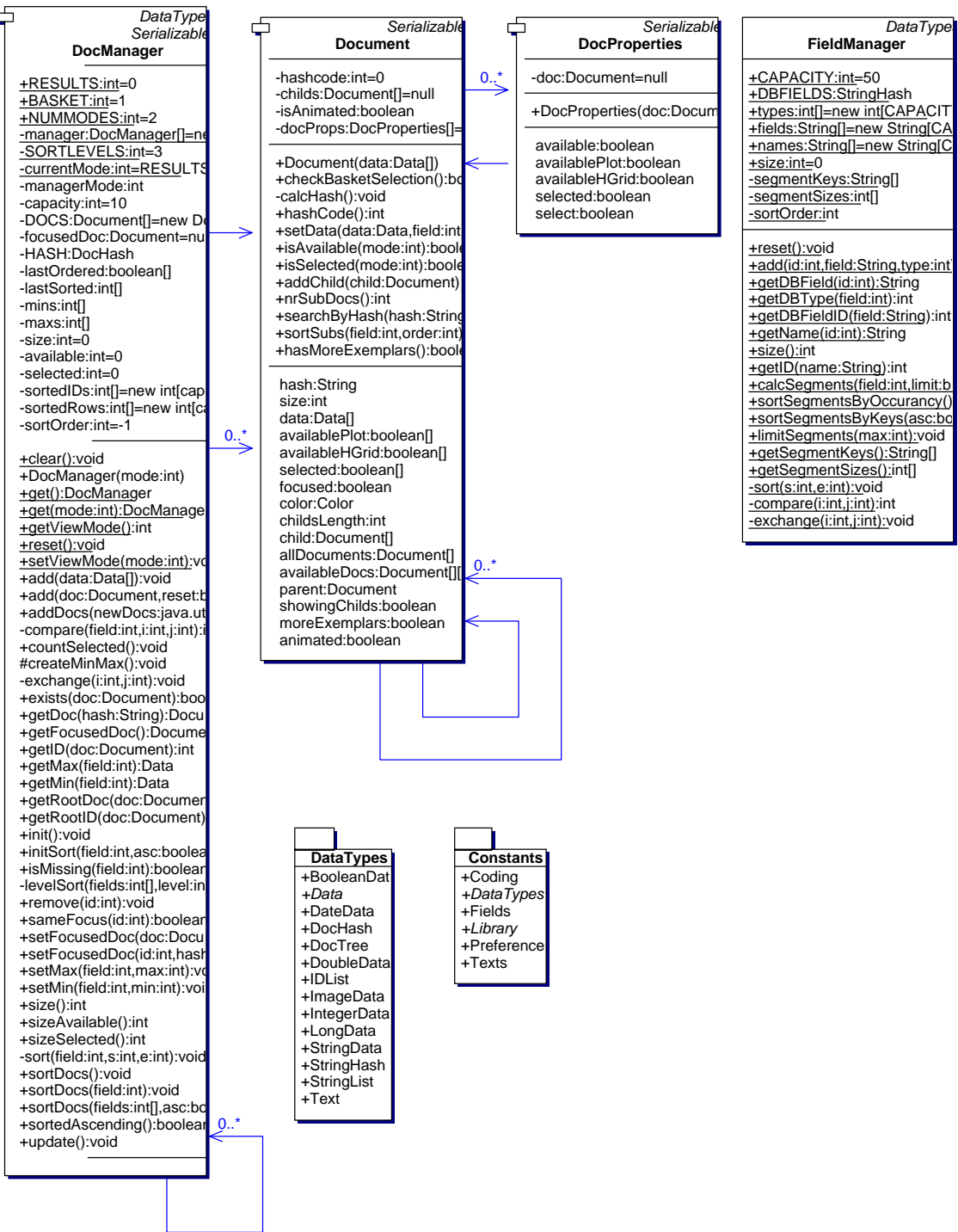

## Temporary and persistent data (Serialization)

→ Independent data, identical interface

- More instances of the data model
- Save switching by well defined interfaces
- Identification by unique hash value
- Easy transfer between instances (garbage management)
- Selection and Focus Synchronization
- Memory optimization by the use of references
- Hierarchical Tree Support

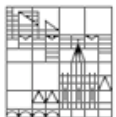

# Data Model Objects

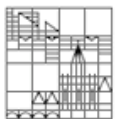
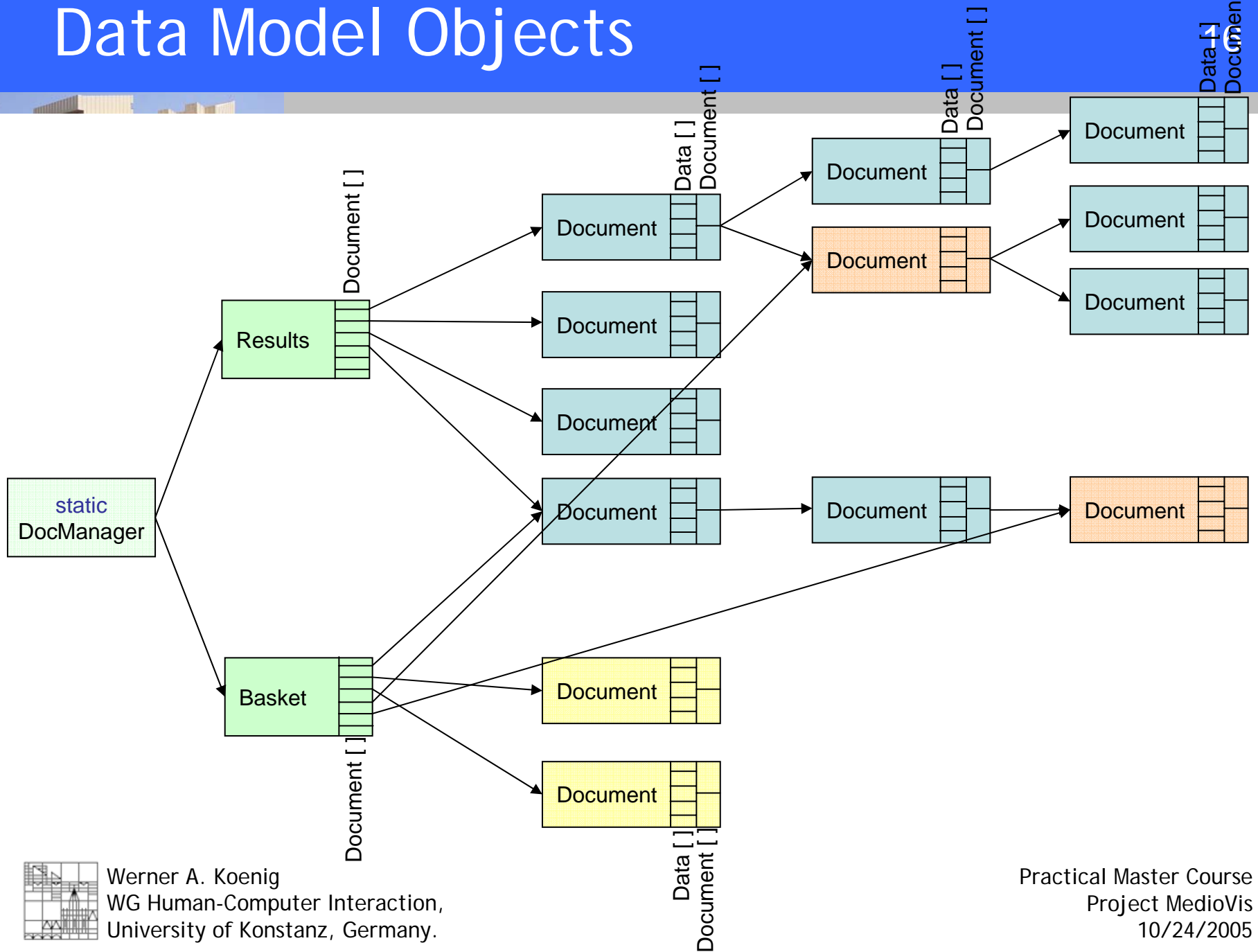



Where to save availability and selection?

- DocManager ? : Independent tree structure needed
  - Document ? : Independent variables needed
- DocProperties for each DocManager at each Document

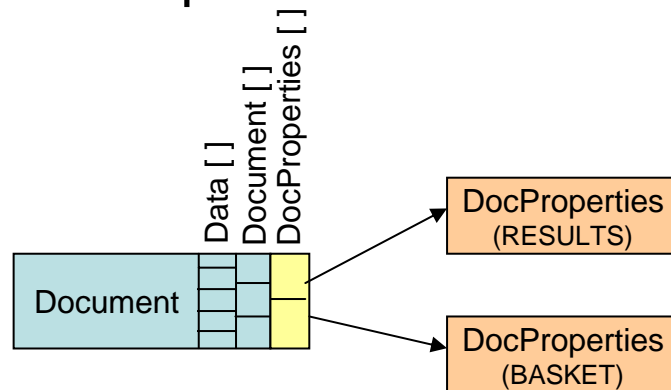

```
public class DocProperties implements Serializable
{
    private boolean availablePlot = true;
    private boolean availableHGrid = true;
    private boolean selected = false;
    private Document doc = null;
    ...
}
```

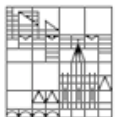

# D.M. Tree

```
public class DocManager implements DataTypes, Serializable {
    private Document[] DOCS = new Document[capacity];
    private int[] sortedIDs = new int[capacity];
    private int[] sortedRows = new int[capacity];
    ...
    public Document getRootDoc(Document doc) {
    }
}
```

```
public class Document implements Serializable {
    private Data[] data;
    private Document[] childs = null;
    private Document parent = null;
    private boolean showingChilds = false;
    private DocProperties[] docProps;
    ...
    public Document[] getAllDocuments() {...}
    public Document[] getAvailableDocs(int mode) {...}
    public Document searchByHash(String hash){...}
}
```

```
public class DocProperties implements Serializable {
    private boolean availablePlot = true;
    private boolean availableHGrid = true;
    private boolean selected = false;
    private Document doc = null;
    ...
}
```

→ Object Oriented Hierarchical Structure

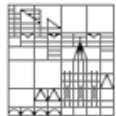
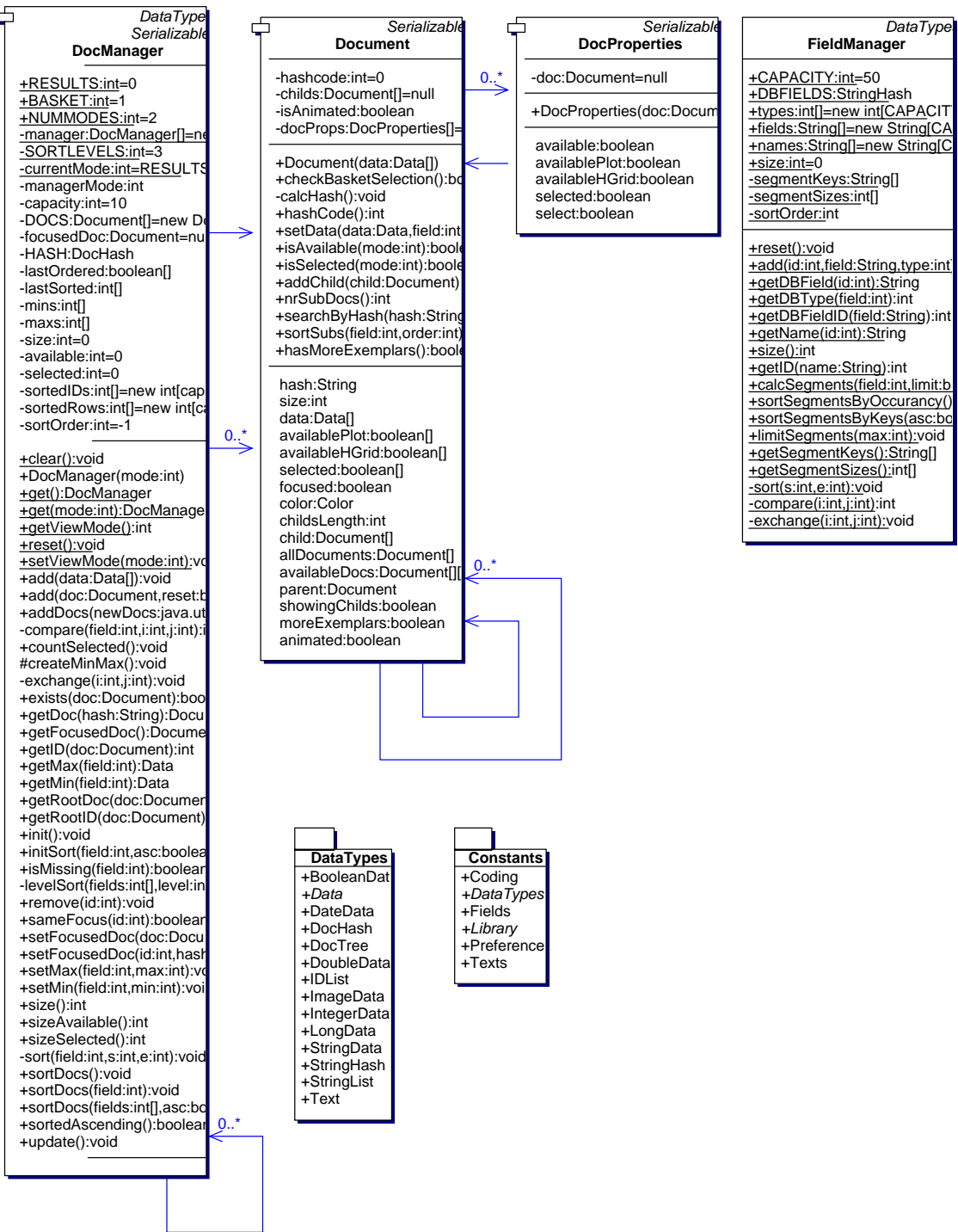

```
public class ViewNotifier {
...
public static void notifyFocus(View source, int id, String hash) {}
...
}

public class ShortListView extends JPanel implements View {

public void repaintFocus(Document doc) {
    DocManager basket = DocManager.get(DocManager.BASKET);
    Document sub = basket.getDoc(doc.getHash());
    if(sub != null) {
        basket.setFocusedDoc(basket.getRootID(sub), sub.getHash());
        panel.jumpTo(sub);
    }
}

public void checkFocus(final int yPosition) {
    Document document = getCurrentDoc(yPosition);
    int resultID = DocManager.get(DocManager.RESULTS).getRootID(document);
    ViewNotifier.notifyFocus(view, resultID, document.getHash());
}
}
```

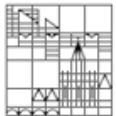

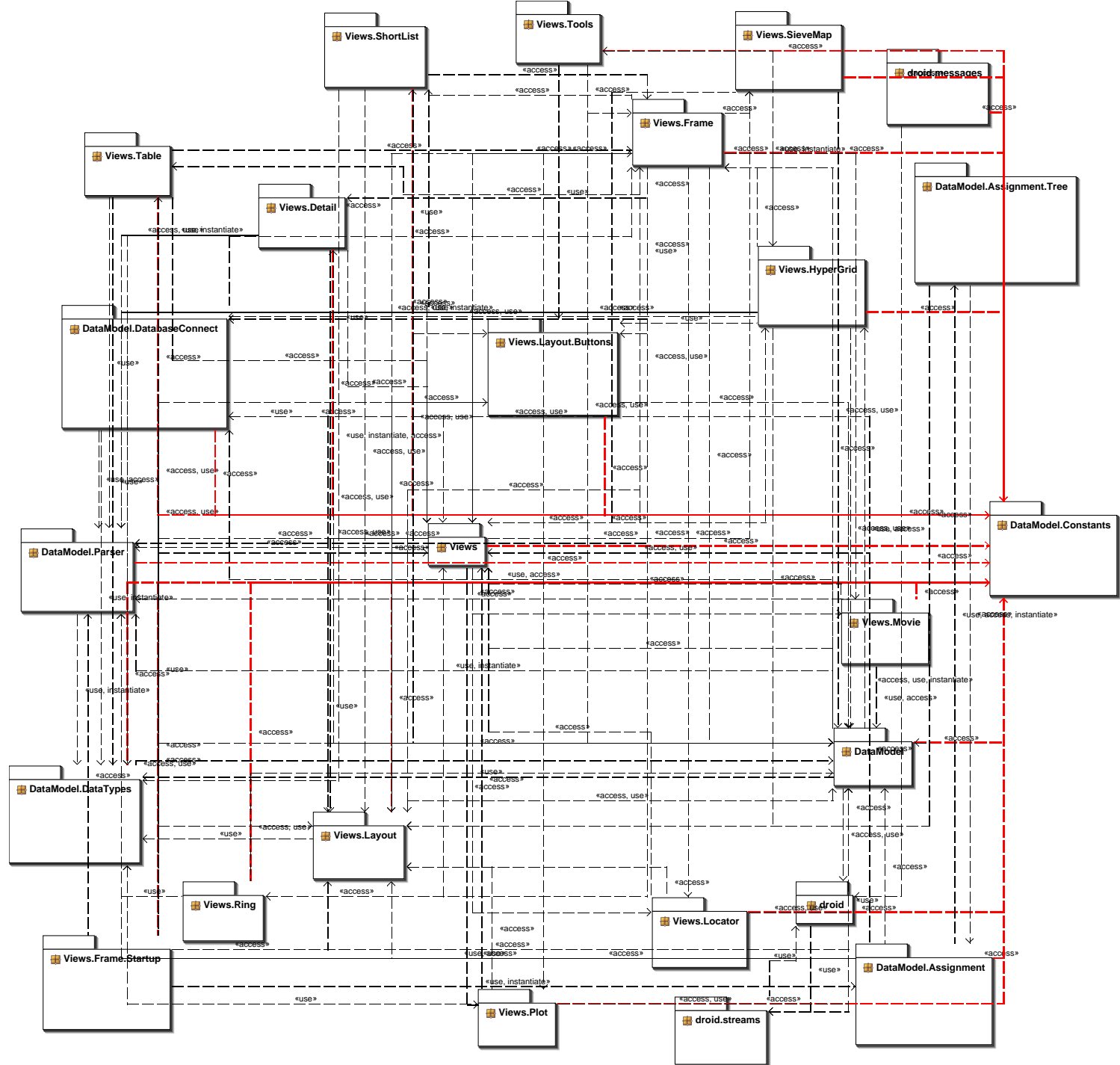

- Performance Optimization:
  - Caching of unchanged tree structure
  - Initiate Basket Properties only when needed
- Extend DocManager to “FavoriteManager” for Personalization
- Integration of Graph Visualizations
- Level based zooming through document hierarchy
- Visual and Interaction Concept for hierarchical Data in HyperGrid, Scatterplot,...

